

New River Community College

Board Member Handbook



Produced by the President's Office
August 2000
Last Revision: August 2024

Table of Contents

I.	The Virginia Community College System (VCCS)	
A.	Mission/Vision.....	2
B.	State Board Members.....	3
C.	Chancellor’s Cabinet.....	4
D.	VCCS Statistical Profile	5
II.	New River Community College (NRCC)	
A.	Mission/Vision and Goals.....	2
B.	Fact Sheet (NRCC Profile)	4
C.	Organizational Chart.....	6
D.	Duties/Responsibilities of the President	7
E.	Duties/Responsibilities of the President’s Staff.....	8
F.	President’s Staff Listing.....	14
G.	Functional Area Manager Listing	14
H.	General information (Source: <u>NRCC Catalog</u>).....	15
I.	Annual Student Enrollment Summary	18
III.	New River Community College Board	
A.	Duties and Responsibilities (Source: <u>VCCS Policy Manual</u>).....	1
B.	Members	9
C.	Standing Committees	11
D.	Terms of Appointment.....	12
E.	Schedule of Meetings.....	13
F.	Schedule to Review College Mission Statement	14
IV.	Curriculum Development	
A.	Calendar and Process	1
B.	Definitions.....	3
C.	Overview Table.....	4
D.	NRCC Programs section.....	6
E.	Curriculum Advisory Committees.....	10
V.	NRCC Educational Foundation	
A.	Overview.....	1
B.	List of Endowed Scholarships	2
C.	Board of Directors.....	5
VI.	Minutes	
VII.	Maps	

Section I
The Virginia Community College System (VCCS)

Statement of Mission

The mission of the Virginia Community College System is simple:

We give everyone the opportunity to learn and develop the right skills so lives and communities are strengthened.

Accelerate Opportunity in Virginia A Six-Year Statewide Strategic Plan for Virginia's Community Colleges

Virginia's State Board for Community Colleges has adopted the Strategic Plan, a strategic plan that will guide Virginia's Community Colleges over the next six years. The plan has this over-arching goal:

Award 300,000 cumulative meaningful credentials by 2030 across all regions through accelerated access and success for every student.

The Virginia Community College System

State Board

The State Board for Community Colleges is the governing body of the Virginia Community College System. Appointed by the Governor for up to two four-year terms, the board's 15 members meet six times a year to set policy for all of Virginia's Community Colleges.

The current State Board chair is Ms. Terri Thompson; vice chair is Mr. Michael Eric Wooten. Dr. David Doré, Chancellor of the Virginia Community College System, serves as the State Board secretary and chief executive officer.

The members are charged with the responsibility of serving the best interest of the whole state. A principal objective of the State Board is to provide and maintain a system of comprehensive community colleges through which appropriate educational opportunities and programs shall be made available throughout the state. In providing these offerings, the State Board recognizes the need for excellence in all curricula and endeavors to establish and maintain standards appropriate to the various purposes of the respective programs.

The State Board has the right to confer diplomas, certificates, and associate degrees. It also establishes the policies providing for the creation of New River Community College and the procedures and regulations under which NRCC's local board operates.

Members and Officers, 2024-2025

Ms. Terri Thompson, Chair
Mr. Michael Eric Wooten, Vice Chair
Dr. David Doré, Chancellor, Secretary

Edward C. Dalrymple, Jr.
Virginia

Jeffrey V. Haley
Virginia

Maurice Jones
Virginia

Anthony “Tony” Miller
Virginia

Terri Thompson (Chair)
Virginia

David Elmore
Virginia

Mark J. Hourigan
Virginia

Peggy Layne
Virginia

Alethea “AJ” Robinson
Virginia

Dr. Michael Eric Wooten
Virginia

Dr. Sasha Gong
Virginia

Wiley “Bif” Johnson
Virginia

Bruce Meyer
Virginia

Jeremy Satterfield
Virginia

Michel Zajur
Virginia

Chancellor

The Chancellor is the chief executive officer of the Virginia Community College System and is appointed by the State Board for Community Colleges. It is the duty of the Chancellor to formulate such rules and regulations and provide such assistance in his office as will be necessary for the proper performance of the System. The State Board prescribes the duties of the Chancellor in addition to those duties otherwise prescribed for him/her by law; and, in its discretion, approved the appointment by the Chancellor of such agents and employees as may be needed by the Chancellor in the exercise of the functions, duties, and powers conferred and imposed by law in order to effect a proper organization to carry out these duties.

VCCS Chancellor and Staff, 2024-2025

Chancellor: Dr. David Doré

Chancellor's Cabinet: Dr. Craig Herndon
Senior Vice Chancellor for Administration, Finance and Technology

Ms. Mary Barnett
Assistant Director of Internal Audit

Ms. Malinda Carter
Associate Vice Chancellor for Human Resources

Ellen Davenport
Assistant Vice Chancellor for Governmental Relations

Dr. Jennifer Gentry
Vice Chancellor for Institutional Advancement

Mr. William Johnson
Associate Vice Chancellor for Finance

Ms. Susan Pollard
Assistant Vice Chancellor for Strategic Communications

Dr. Michael Russell
Chief Information Officer

Ms. Noelle Shaw-Bell
Legal Counsel

Mr. Randall Stamper
Assistant Vice Chancellor, Grants and Federal Programs

Mailing Address: 300 Arboretum Place
Suite 200
Richmond, VA 23236

VCCS Statistical Profile

With 23 colleges on 40 campuses located throughout the state, Virginia's Community Colleges are committed to serving Virginia families, helping them acquire the knowledge and skills to seize the opportunities of today and tomorrow. Here, you can see some of how we're doing that by the numbers:

- The cost per credit hour is \$163.
- The annual headcount enrollment for 2023-2024 was 207,108.
- Full-time enrollment headcount for fall 2023 was 151,034.
- The number of FTEs for fall 2023 was 82,383.
- The percentage of Dual Enrollment students for fall 2023 was 31%.
- The number of Virginia Community College students in distance learning for 2023-2024 was 145,424.
- The number of degrees, diplomas and certificates earned in 2023-2024 at Virginia's Community Colleges was 29,297.
- The number of Virginia Community College transfer students for 2022-2023 was 77,243.
- The percentage of Virginia Community College students in distance learning is 62%.
- The number of unique career/tech students for 2023/2024 at Virginia's Community Colleges was 49,369.
- The number of FastForward credentials earned since 2016 at Virginia's Community Colleges was over 52,900.

Section II
New River Community College (NRCC)

OUR MISSION/PURPOSE

New River Community College, a member of the Virginia Community College System (VCCS), subscribes to the tenets set forth in the VCCS mission statement. This statement is as follows:

New River Community College (NRCC), a member of the Virginia Community College System, subscribes to the tenets set forth in the system's mission statement: "We give everyone the opportunity to learn and develop the right skills so lives and communities are strengthened."

In addition, NRCC is committed to the ideal that communities are strengthened when all members are offered opportunities to develop their skills and knowledge, regardless of race, ethnicity, religion, culture, social class, economic status, age, gender, sexual orientation, personal identity or physical or mental capability. NRCC strives to support individuals in understanding and embracing their roles as citizens while enhancing their sense of self-esteem, personal security and autonomy.

In meeting the educational needs of the New River Valley, the college assumes a responsibility to provide educational opportunities through collaborative efforts with local industries, businesses, government institutions and non-profit organizations. NRCC also seeks to strengthen lives by promoting regional economic development and is dedicated to engaging in partnerships with higher education institutions, public schools and other entities.

In fulfilling its mission, NRCC offers a variety of certificate, diploma, associate degree and workforce development programs. The institution is committed to assisting students with decisions concerning their educational, career and personal goals and being a place that brings together people of disparate experience while fostering community and cultural enrichment.

OUR VISION

"Through forward-looking leadership, efficient management and the deep commitment of faculty and staff to provide the best possible teaching and learning environment, the college aims not only to meet the educational challenges of the coming decades, but to welcome them. Accordingly, New River Community College embraces the following beliefs:

"That student learning is the ultimate priority for the college and to best serve students there must be maintained the highest level of commitment achieved by focusing on the teaching/learning process and by providing support for the personal development of each student served;

"That instruction must remain the primary function of the college, with other college functions to be supportive of or complementary to the instructional program;

"That access to higher education must be provided to all who can benefit from it;

"That high quality must be maintained in all programs and services through instructional excellence, competency of faculty and staff, on-going curriculum development and improvement, and effective processes for assessment of quality;

"That the college must foster a spirit of innovation through technological advancements and through continuous improvement of programs and services;

"That a positive institutional climate must be maintained which supports high ethical standards, professionalism, faculty and staff development, and an inclusive environment based on dignity and respect for all persons;

"That the college must be community centered as reflected by comprehensive and affordable programming, linkages and partnerships with other organizations, community outreach efforts, fostering of an appreciation for education in the community, and continued responsiveness to community needs;

"That the college must support multi-cultural diversity as well as equal opportunity for all persons, and that the institution must be outward looking as it fulfills its local mission;

"That the college must focus continually on institutional effectiveness with emphasis on accountability, assessment, good management practices, employability of graduates, comprehensive planning processes, and the overall improvement of organizational effectiveness."

NRCC Profile

Purpose: New River Community College (NRCC) is a state-supported two-year college with the primary mission of meeting the educational needs of its students and of its service region through excellence in teaching and leadership in community service.

Service Region: The college's service region includes Floyd, Giles, Montgomery, and Pulaski counties, and the city of Radford.

Location: NRCC's campus is located at 5251 College Drive in Dublin, Virginia. The mailing address is 5251 College Drive, Dublin, VA 24084. The main telephone number is 540-674-3600. The college's Christiansburg site is located at 782 New River Road, NW in Christiansburg, Virginia.

Enrollment: Official fall headcount enrollment of 4,161 students (2023). Annualized full-time equivalent enrollment of 2,533 (2023-24). Over the past three fall semesters, about 45 percent of non-dual enrolled students have been full-time. About 50 percent have been female, and about 50 percent male. About 80 percent of students took at least one distance education course.

Faculty and Staff: Full-time staff of 47 teaching faculty, 24 administrative and 54 classified positions. Total college staff of 125 in spring 2024.

Budget: Gross revenues of approximately \$38.8 million in 2023-2024, including approximately \$32.3 million in state appropriations, \$6 million in federal funds, \$500,000 in local appropriations.

Local Schools: County-operated and city-operated public schools include nine high schools and Southwest Virginia Governor's School in the area. Institutions of higher learning include Radford University and Virginia Polytechnic Institute and State University (Virginia Tech).

Programs:

Associate of Applied Science	Accounting, Administrative Support Technology, Business Management, Early Childhood Development Specialization, Electrical Engineering Technology, Electronics Technology, Engineering Design Technology, Forensic Science, Human Services, Information Technology, Information Technology Cloud Computing Specialization, Information Technology Cyber Security Specialization, Information Technology Network and Technical Support Specialization, Information Technology Stack Specialization, Instrumentation and Control Automation Technology, Machine Technology, Medical Administrative Support Specialization, Nursing, Paralegal Administrative Support Specialization, Police Science
Associate of Arts and Sciences	Business Administration, Education, Engineering, Engineering Computer Science Specialization, Fine Arts Specialization, General Studies, General Studies Computer Science Specialization, Liberal Arts, Science, Visual Communication Design Specialization
Certificate	Early Childhood Development, Human Services, Practical Nursing, Uniform Certificate of General Studies, Welding
Career Studies Certificate Options:	Accounting/Keyboarding, Accounts Receivable/ Payable, Administrative Assistant, Advanced Manufacturing I, Advanced Manufacturing II, Alternative Energy, Automotive Drivability, Basic Machine Tool Operations, Child Development, Child Development: Infant & Toddler, Computerized Numerical Control, Construction Technology, Cost Accounting Clerk, Cyber Security, Cyber Security and Networking Foundations I, Cyber Security and Networking Foundations II, Electrical-Construction Technology, Electricity, Emergency Medical Technician, Engineering Design Fundamentals I, Engineering Design Technology, Engineering Design Fundamentals II, Foundations of Criminal Justice, Health Professions Preparations, Human Resource Practices, IT- Foundations, IT Network, IT Software Design, Industrial Maintenance I, Industrial Maintenance II, Machine Operations, Machine Technology Fundamentals I, Machine Technology Fundamentals II, Management Practices, Mechatronics Fundamentals, Applied Mechatronics, Medical Coding Foundations I, Medical Coding Foundations II, Medical Office Assistant, Nurse Aide, Operator, Paralegal Assistant, Payroll Clerk, Practical Electrical Technician I, Practical Electrical Technician II, Practical Electrician I, Practical Electrician II, Practical Electrical Energy Technician I, Practical Electrical Energy Technician II, Practical Electronics Technician I, Practical Electronics Technician II, Refrigeration and Air Conditioning, Unmanned Systems, Welding – Fundamentals, Welding- Advanced Welder
Diploma	Automotive Analysis Repair

**New River Community
College
2024**

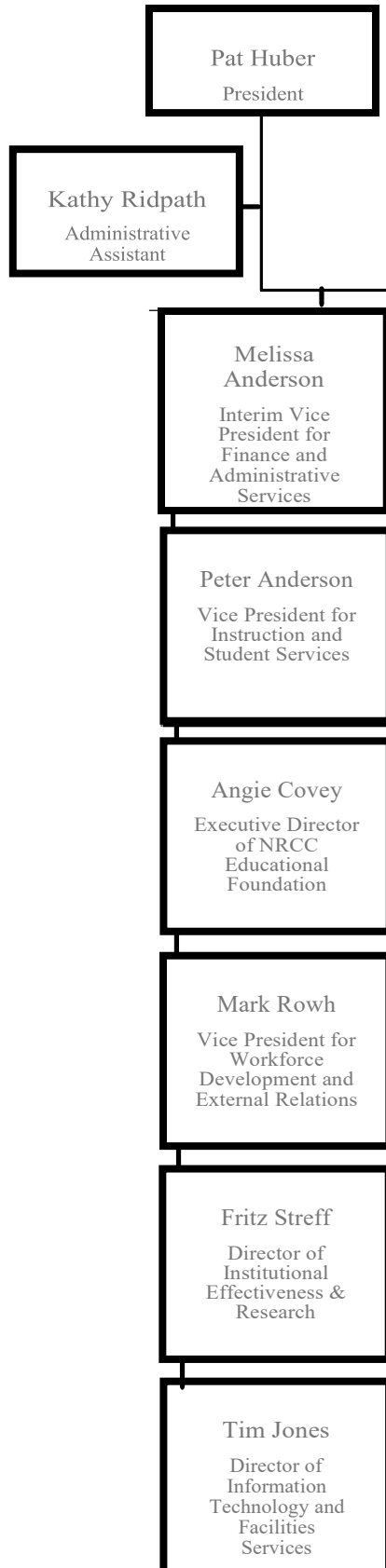

Duties/Responsibilities of the President

The President serves as the college's chief executive office. The President is responsible to the Chancellor of the Virginia Community College System for organizing and operating the community college in accordance with the policies, procedures, and regulations of the State Board for Community Colleges and the Virginia Community College System.

Specific responsibilities of the President include:

1. Provide effective leadership, management, and supervision for the college, including:
 - a. College transfer education, career-technical education, general education, general education, and remedial education;
 - b. Workforce development and external relations;
 - c. Student access and student services, including advising, student admissions and records, financial aid, disability services, and student activities;
 - d. Budget planning and fiscal management;
 - e. Institutional effectiveness and research;
 - f. Management and development of campus sites and facilities;
 - g. Management and implementation of campus technology;
 - h. Recruitment, selection, professional development, and evaluation of human resources; and
2. Assume responsibility for student enrollment growth relative to the growth of the college's service region;
3. Develop and maintain effective regional and community relations;
4. Provide leadership for institutional resource development, serving as liaison to the NRCC Educational Foundation and actively pursue grants, gifts, and other resources;
5. Serve as advocate on behalf of the college and VCCS with local, state, and federal legislators;
6. Represent the college at appropriate local, state, and national events;
7. Maintain an active program of professional development;
8. Serve as secretary to the Local College Board;
9. Serve as a member of the VCCS Advisory Council of Presidents;
10. Support the work for the college and VCCS as requested by the Chancellor.

Duties and Responsibilities of the President's Staff

Vice President for Instruction and Student Services

The Vice President for Instruction and Student Services serves as the college's chief academic and student services officer. The Vice President leads the instructional process including the curriculum review process and provides support services to students.

Primary job duties and responsibilities include:

1. Serves as the chief academic and student services officer with responsibility for the development and delivery of high-quality programs and services.
2. Serve as a member of the executive team, working cooperatively with other senior leaders and members of the college community to carry out the mission, vision, and strategic goals of the institution.
3. Provide academic and administrative leadership for all instructional programs to include curriculum development, assessment and program review, academic planning, and instructional technology.
4. Work cooperatively with Workforce Development to ensure the college offers a well-coordinated range of credit and noncredit programs.
5. Provide leadership in strategic planning and budget management for instructional and student services.
6. Provide leadership for faculty selection, development, and evaluation.
7. Provide overall leadership for student services, recognizing the role student services plays in supporting the instructional programs and in promoting student retention and success.
8. Ensure compliance with requirements for regional and specialized accreditation.

Interim Vice President for Finance and Administrative Services

The Interim Vice President for Finance and Administrative Services is the chief financial officer of the college and reports directly to the President of New River Community College. The Interim Vice President for Finance and Administrative Services is responsible for administering and supervising Human Resources and Business Office. As chief financial officer, the Interim Vice President for Finance and Administrative Services must delegate authority and yet retain final responsibility for the effective fiscal operation of the college.

Primary job duties and responsibilities include:

1. Finance

Provide leadership for college financial functions, including:

- Development and monitoring of operating and strategic budgets
- Management of local funds and miscellaneous income
- Cash flow and investments
- Contract administration
- Internal controls, audit, and risk management
- Contract and grant administration
- Business Office management
- Procurement
- Accounts payable
- Accounts receivable
- Student accounts

2. Administrative Services

Provide leadership to several college administrative functions, including:

- Human Resources
- Title IX coordination for employees
- College's emergency response planning team

3. Perform other duties as assigned by the President

Director for Information Technology and Facilities Services

The Director for Information Technology and Facilities Services is the Chief Information Officer and Chief Facilities Officer of the college and reports directly to the President of New River Community College. The Director for Information Technology and Facilities Services is responsible for administering and supervising Information Technology, Facilities Services, Security, and Emergency Response. As Chief Information officer, the Director for Information Technology and Facilities Services must delegate authority and yet retain final responsibility for the effective technological and facilities operations of the college.

1. Information Technology Services

Provide overall leadership to the college for information technology planning. Ensure that all VCCS technical guidelines and useful life are met or surpassed. Collaborate with VCCS staff (System Office and other colleges) to produce information systems and updates to existing systems to meet the needs of New River Community College. Ensure that the college's information technology network and services are balanced with regard to six key areas: hardware, software, infrastructure, security, training and support. Play a strategic role in the development of automated systems designed to improve efficiency, productivity, and quality of services related to business functions and to the faculty and staff as it applies to other areas managed. Provide leadership for the integration of

information technology systems into all administrative and teaching and learning functions of the college - specifically:

- Accounting and Financial Systems (AIS, CARS, PeopleSoft)

- Procurement Systems (eVA, Shared Services)
- Budgeting Systems (automated budget model and monitoring system)
- Strategic Planning and Budgeting Systems (NETSPACE)
- Facilities Management Systems (support, work scheduling, climate control, and others)
- Personnel and Payroll Systems (HRMS, PMIS, CIPPS, PeopleSoft)
- Research and Assessment Systems (PAS, RADSS)
- Integration of technology into the teaching and learning activities of the college (electronic classrooms, distance education and Web-based course development)
- Development and monitoring of IT operating and strategic budgets

2. Facilities Services

Provide leadership for college facilities functions, including:

- Monitoring and reporting on major college facilities projects including capital outlay and site planning
- Development and monitoring of Facilities operating and strategic budgets
- Foster collaboration and coordination between Facilities and IT departments on college projects involving both areas

3. Security / Emergency Response

Provide leadership for the college's security and emergency response team.

4. Perform other duties as assigned by the President

Vice President for Workforce Development & External Relations

The Vice President for Workforce Development and External Relations serves as the college's chief workforce development officer and as the institution's chief public relations/government relations officer. The Vice President is responsible for representing the college in partnerships with business and economic development organizations, directing marketing and public information efforts and serving as a member of the institution's leadership team.

Primary jobs duties and responsibilities include:

1. Provide leadership in planning, implementing and evaluating a full spectrum of noncredit workforce development programs and services.
2. Serve as the college's primary point of contact with the workforce development arm of the Virginia Community College System, including membership on the VCCS Workforce Development Advisory Council.
3. Provide administrative leadership in offering selected credit courses.

4. Provide leadership in representing NRCC to the public through a comprehensive marketing/public information program.
5. Represent the college in communications with legislators and other government representatives/officials.
6. Represent the college in matters of regional economic development, including maintaining close working relationships with economic development entities and personnel.
7. Serve as the college's liaison with the Southern Association of Colleges and Schools, Commission on Colleges.
8. Supervise administration of the institution's pre-college programs for adults including the regional adult education program.
9. Provide support to the President as a member of the college leadership team.
10. Perform other duties as assigned by the President, currently including roles as the college's Equal Opportunity Officer, FOIA officer, Intellectually Property Officer, and chair of the DEI Task Force.

Executive Director, NRCC Educational Foundation

The NRCC Educational Foundation (NRCCEF) Executive Director is responsible for the management and daily operations of the NRCCEF and reports directly to the college president. Additionally, the executive director works with the Foundation Board in fulfilling the organization's mission.

Primary job duties and responsibilities include:

1. Provide leadership as the NRCCEF's chief executive officer, resource development officer and spokesperson.
2. Serve as the point of contact for collaboration between the five localities (Floyd, Giles, Montgomery Counties, Pulaski County, and the City of Radford) for funding and management of the NRCC ACCE (Access to Community College Education) program.
3. Schedule, coordinate and participate in the NRCCEF Board of Directors meetings, sharing reports and updates on all Foundation activities.
4. Oversee the creation, development and execution of Foundation programs, policies and procedures.
5. Coordinate the annual audit as directed by the NRCCEF Board of Directors.
6. Coordinate oversight of Foundation endowments and asset management with the NRCCEF Board of Directors.

7. Plan and coordinate multi-faceted fundraising efforts seeking donations from corporations, alumni, local citizens and other potential donors. This includes planning, scheduling, initiating and coordinating targeted campaigns and fundraising strategies, contacting potential donors and employing various persuasive strategies to solicit gifts.
8. Design and write proposals, brochures, and other campaign materials, developing donor research strategies, conducting research, analyzing data and implementing plans for targeting donors based on research.
9. Write and submit grant proposals for funding from local, state, and national organizations.
10. Manage the NRCCEF annual operational budget, annually update the memorandum of agreement between the college and the NRCCEF and keep all governing documentation current between the NRCCEF and the NRCCEF Board of Directors.
11. Plan and implement fundraising events, including an annual event for benefactors and scholarship recipients to come together for recognition.
12. Other duties as assigned by the president, currently including:
 - a. Campus Beautification Committee Chair
 - b. Involvement on committees and boards in the college's service region.

Director of Institutional Effectiveness and Research

The Director of Institutional Effectiveness manages and supervises a comprehensive program of institutional effectiveness, including data collection, analysis, interpretation, and reporting to support operational decision-making. Reporting directly to the President, the Director of Institutional Effectiveness and Research is the official contact with state agencies for data analysis.

Primary job duties and responsibilities include:

1. Conduct studies relevant to college programs, services, and activities including, but not limited to, student follow-up, student services, program evaluation, faculty-administrative evaluation, student enrollment patterns, student profiles, instructional cost, faculty data, program planning, and space utilization.
2. Assist in designing and implementing assessment plans, conducting regular program reviews, and interpreting data.
3. Assist faculty and staff in identifying, planning, and initiating surveys and studies relevant to instruction and college operations.
4. Provide research support and assistance in collecting data while ensuring the integrity of data collection, analysis, and dissemination.
5. Generate research information essential to the college's planning process.

6. Prepare federal- and state-mandated institutional profile information and coordinate/monitor compliance with data reporting requirements.
7. Consult with and support policy and planning functions engaged in institutional self-study or assessment, program review processes, institutional effectiveness and accreditation processes.
8. Perform other duties as assigned.

President's Staff

Dr. Peter Anderson	Vice President for Instruction and Student Services
Ms. Melissa Anderson	Interim Vice President for Finance and Administrative Services
Ms. Angie Covey	Executive Director of NRCC Educational Foundation
Dr. Patricia Huber	President
Mr. Timothy Jones	Director of IT and Facilities Services
Ms. Kathy Ridpath	Administrative Assistant to the President
Dr. Mark Rowh	Vice President for Workforce Development and External Relations
Dr. Fredrick Streff	Director of Institutional Effectiveness and Research

Functional Area Managers

(In addition to the President's Staff)

Mr. Brian Bolling	Technology Services Manager
Mrs. Linda C. Claussen	Director of Distance Education
Ms. Kimberly Brewer	Interim Financial Aid Manager
Dr. Diane Gray	Director of Transitional Programs
Dr. Deborah Kennedy	Dean of Student Services
Mr. Ross Matney	Workforce Training Coordinator
Ms. Lori Mitchell	Dean of Business and Technologies
Dr. Heidi Morehead	Assessment Coordinator
Mr. Ronnie Nichols	Director of Facilities Services
Ms. Lisa Dinkle	Library Services Coordinator
Ms. Tammy Smith	Coordinator of Admissions and Records
Dr. Jeanne Symanoskie	Coordinator of Workforce Training Montgomery County
Ms. Sarah Tolbert-Hurysz	Dean of Arts and Sciences
Mr. Tyler Lundy	Media Services Manager
Ms. Helen Wolfe	Dean of Health Professions

General Information

New River Community College is a two-year institution of higher learning operating under a state-wide system of community colleges. The college serves those who live in the counties of Floyd, Giles, Pulaski, Montgomery, and the city of Radford.

The college acts under policies set up by the State Board of Community Colleges and the local Community College Board. The school is funded mainly with state funds, but the participating localities also add to the support of the college.

The college is open on a year-round basis under the semester system. Classes are held from 7:00 am to 10:00 pm. Since college credit courses are offered in the evening and on weekends, students who work may also attend college.

History

In 1959 New River Community College began offering vocational/technical courses as a vocational/technical school to residents in the New River Valley. It is one of five colleges which developed from existing vocational/technical schools into community colleges under 1966 General Assembly legislation which formed the Virginia Community College System.

The Local Board was established in August 1969 and the college was named New River Community College. The college continued the career/technical degrees in Machine Shop, Drafting and Design, Auto Mechanics, Practical Nursing, Industrial Electricity, Electronics, Instrumentation, Clerk Typing, and Stenography.

Programs leading to the Associate in Applied Science Degree in Accounting, Business Management and Secretarial Science were added in the fall term of 1970. Degree programs designed for transfer to four-year colleges were also offered at that time. These included the Associate of Arts Degree program in Liberal Arts and the Associate of Science Degree programs in Science, Education, Business Administration, and General Studies.

Location and Facilities

The college is located on a one-hundred-acre site at the intersection of US Routes 11 and 100 in Dublin, Virginia. The campus provides modern, well-equipped facilities for the vocational/technical programs as well as for university-parallel programs.

The facilities contain labs for Administrative Support Technology, Accounting, Automotive, Computer Aided Drafting and Design, Electronics, Electricity, Forensic Science, Information Technology, Instrumentation, Machine Shop, Natural Science classes, Nursing, Programmable Logic Controllers, and Welding.

Besides the special labs, there are general classrooms, a large lecture room, a modern library, a learning lab, a spacious industrial training room, a student center, an auditorium, and faculty and administrative offices.

The college's Christiansburg site, located in Uptown Christiansburg, offers increased educational opportunities to residents of Floyd, Giles, Montgomery, and Pulaski Counties and the city of Radford. Faculty from the college's teaching divisions provide high quality instruction equivalent to on-campus instruction.

In addition to the Dublin and Christiansburg locations, the college makes use of public schools, industrial plants, and other facilities off campus to provide instruction that is closer to the people served by the college.

Programs

New River Community College offers programs two years beyond the high school level.

Career/Technical Education

The career and technical education degrees are designed to meet the demand for technicians, semi-professional workers, and skilled craftsmen in the New River Valley who will be employed in industry, business, the professions, and government.

University Parallel/College Transfer Education

The university parallel/college transfer programs include college freshman and sophomore courses in arts and sciences and pre-professional education. These courses meet the standards for transfer to baccalaureate degree programs in four-year colleges and universities.

General Education

The courses in general education include common knowledge, skills, and attitudes needed by an individual to be effective as a person, a worker, a consumer, and a citizen.

Continuing Education

Degree credit and non-degree credit courses are offered during the day and evening hours for adults in the region wishing to continue learning.

Customized Training Programs

Customized training is offered where specific employment chances are open for new or expanding industry. Customized training programs are coordinated with Virginia's economic growth efforts and with the needs of employers.

Developmental Courses

Basic or developmental courses are designed to prepare people for admission to college transfer and career/technical education courses of study in the community college. These courses are designed to assist the person with basic skills and knowledge needed to succeed in other community college programs.

Recognition

The college, part of the Virginia Community College System, is governed by the State Board for Community Colleges in Virginia. The college's associate degree courses are approved by the State Council of Higher Education for Virginia.

The college has been fully approved by the State Department of Education for payment of veteran's benefits as well as by other state and federal agencies for funding. Also, this school is authorized under Federal Law to enroll nonimmigrant alien students.

The college is an institutional member of the American Association of Community Colleges and a number of other state and national organizations.

Accreditation

New River Community College is accredited by the Southern Association of Colleges and Schools Commission on Colleges (SACSCOC) to award associate degrees. New River Community College also may offer credentials such as certificates and diplomas at approved degree levels. Questions about the accreditation of New River Community College may be directed to the Southern Association of Colleges and Schools Commission on Colleges at 1866 Southern Lane, Decatur, Georgia 30033-4097, by calling 404-679-4500, or by using information available on SACSCOC's website at (www.sacscoc.org).

Official Headcount By Term

Year	Summer	Fall	Winter	Spring	Regular Session	Annual
1970-71	107	637	607	637	N/A	901
1971-72	211	1,006	894	880	N/A	1,337
1972-73	452	1,368	1,285	1,411	N/A	2,313
1973-74	769	1,715	1,432	1,394	N/A	2,540
1974-75	701	1,864	1,750	1,767	2,700	2,973
1975-76	947	2,262	2,169	2,063	3,075	3,336
1976-77	775	2,323	2,090	1,998	3,339	3,570
1977-78	865	2,786	2,114	2,013	3,826	4,194
1978-79	782	2,796	2,226	2,194	4,294	4,528
1979-80	1,126	2,716	2,342	2,575	4,395	4,811
1980-81	1,368	3,141	2,930	2,916	5,415	5,660
1981-82	1,132	2,985	2,740	2,771	4,980	5,141
1982-83	957	3,044	2,937	2,872	4,927	5,207
1983-84	1,060	2,776	2,807	2,667	4,729	5,058
1984-85	1,147	2,737	2,446	2,346	4,289	4,825
1985-86	1,183	2,738	2,686	2,559	4,609	5,103
1986-87	1,268	3,076	2,967	2,817	5,197	5,820
1987-88	1,514	3,419	2,855	2,713	5,179	5,969
1988-89*	890	3,044	-----	2,995	4,784	5,132
1989-90	1,460	3,619	-----	3,521	5,465	6,207
1990-91	1,697	3,703	-----	3,732	5,592	6,303
1991-92	1,527	3,738	-----	3,483	5,121	5,767
1992-93	1,639	3,582	-----	3,618	5,048	5,767
1993-94	1,675	3,703	-----	3,335	4,886	5,610
1994-95	1,196	3,126	-----	3,287	4,539	5,107
1995-96	1,304	3,435	-----	3,572	5,088	5,721
1996-97	1,399	3,533	-----	3,643	5,184	5,860
1997-98	1,399	3,501	-----	3,659	5,037	5,675
1998-99	1,317	3,595	-----	3,619	4,979	5,632
1999-00	1,304	3,487	-----	3,734	5,172	5,751
2000-01	1,366	3,692	-----	3,714	5,171	5,809
2001-02	1,626	3,947	-----	4,022	5,406	6,157
2002-03	1,517	3,948	-----	3,975	5,479	6,138
2003-04	1,544	4,325	-----	4,297	5,916	6,624
2004-05	1,528	4,073	-----	4,228	5,633	6,321
2005-06	1,455	3,928	-----	3,952	5,366	6,061
2006-07	1,512	4,042	-----	4,221	5,640	6,409
2007-08	1,821	4,610	-----	4,557	6,283	7,272
2008-09	1,923	4,902	-----	4,823	6,743	7,823
2009-10	2,108	5,229	-----	5,367	7,219	8,431
2010-11	2,072	5,178		5,032	6,975	8,014

Section II, NRCC

Year	Summer	Fall	Winter	Spring	Regular Session	Annual
2011-12	1,978	5,207	-----	5,180	7,052	8,042
2012-13	1,672	5,083	-----	4,597	6,575	7,423
2013-14	1,547	4,808	-----	4,346	6,192	7,038
2014-15	1,350	4,601	-----	4,339	5,904	6,617
2015-16	1,440	4,477	-----	4,288	5,844	6,615
2016-17	1,463	4,456	-----	4,177	5,596	6,420
2017-18	1,286	4,626	-----	4,120	5,675	6,402
2018-19	1,366	4,419	-----	3,834	5,410	6,209
2019-20	1,418	4,337	-----	3,921	5,423	6,273
2020-21	1,415	4,139	-----	3,566	4,976	5,809
2021-22	1,134	3,905	-----	3,415	4,790	5,413
2022-23	1,288	3,984	-----	3,573	4,940	5,704
2023-24	1,390	4,161	-----	3,792	5,118	5,918

* Semester Conversion

Section III
The NRCC Board

Appointment, Duties and Responsibilities of Board Members

Excerpts from the VCCS Policy Manual Denoted with Parenthetical References

The community college board shall act in an advisory capacity to the State Board and shall perform such duties with respect to the operation of a single comprehensive community college as may be delegated to it by the State Board. The community college board shall be known as the (New River) Community College Board and may be called the college board. (Section 2.A.2.9D1)

Appointment of Local College Boards

A minimum of nine persons shall be appointed to the college board and shall include at least one person from each political subdivision sponsoring the college. Generally, the maximum number of persons on the college board shall not exceed fifteen persons. (Section 2A-2.9D3a)

Each local political subdivision sponsoring the community college shall appoint its board members as allocated by the ad hoc committee within the guidelines of the State Board. (Section 2A-2.9D3b)

The members of the college board shall be residents of the region to be served by the community college and shall include persons from various businesses, industries, and professions in the region being served by the community college. No elected members of either the General Assembly or of a local governing body shall be eligible to serve on the college board; however, elected town officials shall not be prohibited from serving on a college board so long as such town is not a participating political subdivision sponsoring the college. Additionally, no current or former employee, including current adjunct faculty members, of the community college shall be eligible to serve on the college board. Local college board members serving as of March 2007 who were former full-time employees of the community college would be eligible to serve out the remainder of their current term and be eligible for one additional consecutive term. All members of the college board shall be deemed members at large charged with the responsibility of serving the best interests of the whole region being served by the community college. (Section 2A-2.9D3c)

Members shall be appointed for a term of four (4) years ... and shall become effective on July 1 of the appropriate year No person having served on the community college board for two successive four-year terms shall be eligible for reappointment to the college board for two years. However, a person appointed to fill an unexpired term may be reappointed for two additional four-year terms. (Section 2A-2.9D3d)

Failure to attend meetings of the college board shall constitute cause for the removal and replacement of a college board member. The community college board shall make this determination, and if it is determined that it is in the best interest of the college to have a replacement, the college board shall notify the appropriate sponsoring political subdivision of the need for a replacement. (Section 2A-2.9D3d)

Composition of the Board

The New River Community College Board consists of twelve (12) members. The City of Radford and the Counties of Floyd and Giles have two representatives each and the Counties of Pulaski and Montgomery have three representatives each.

Compensation of Board Members

Members of the college board receive no salaries. However, reimbursement for travel and other official functions required of board members is available at the allowable rate set by the Commonwealth. Travel outside the area served by NRCC will be reimbursed only if authorized by the board. The cost of meals when a board member is on official business will be covered by the college or reimbursed to the board member.

Reimbursement to members for travel, meals, and other direct costs while on official business for the college will be reimbursed upon proper vouchers from the State M&O budget. Travel expenses associated with travel to the Annual Meeting of the State Board for Community Colleges (held in October each year) will be paid directly by the college whenever possible. To facilitate broad participation in this annual event, additional expenses for board members' guests may be paid by the college, subject to approval by the President.

Questions about allowable expenses or requests for reimbursement should be directed to the President's Office.

Officers of the Board

The officers of the board are chairman, vice-chairman, and secretary. The chairman and vice-chairman are elected annually at the regular meeting of the board in June. The term of office is one year. Incumbent officers are eligible for re-election.

The board chairman shall preside at all meetings of the college board, appoint committees, and perform such other duties as may be prescribed by the State Board for Community Colleges or by the college board.

The board vice-chairman shall preside in the absence of the chairman and shall perform such other duties as may be assigned by the college board.

The president of the college serves as secretary. As such, the president keeps such minutes and records as are necessary to set forth clearly all actions and proceedings of the board. The minutes of each meeting shall be considered, corrected if necessary, and approved at the next regular meeting (or at an intervening special meeting, if the board desires). Minutes are signed by the chairman and the secretary after correction and approval and are kept as a public record in the permanent custody of the president.

Committees of the Board

The standing committees of the board are the Budget and Finance Committee, the Building and Site Committee, the Curriculum and Program Committee, and the Personnel Committee. Standing committees are appointed by the chairman for a term of one year.

The Budget and Finance Committee considers matters pertaining to the local capital outlay budget, the local M&O budget, the State capital outlay budgets and the State M&O budget.

The Building and Site Committee considers matters pertaining to the procurement, development, and improvement of the site and the design, construction, and equipping of facilities.

The Curriculum and Program Committee considers matters pertaining to instructional programs, occupational/technical advisory committees, student activities, community service programs, and community relations activities. All proposed instructional programs shall be reviewed and approved by the board for recommendation to the State Board for Community Colleges. Approval of courses and course content with an approved instructional program is delegated to the president by the State Board.

The Personnel Committee considers matters pertaining to college personnel and, primarily, the recruitment and evaluation of the president.

Meetings of the Board

The NRCC Board meets at 7:00 pm on the second Monday of September, the first Monday of December, the first Monday of March, and the first Monday of June unless otherwise changed by the board. Special meetings of the board may be held at the call of the chairman or upon petition of a simple majority of the members of the board.

All board meetings are open to the public, except where a closed meeting is authorized by Section 2.2-3712 of the Virginia Freedom of Information Act. Matters dealing with site selection, personnel, and other matters of a confidential nature will be discussed in closed session. The board convenes and adjourns the closed session in a manner provided in the above-referenced Section.

A simple majority of the members of the board constitutes a quorum for all purposes.

Electronic meetings may be held under certain circumstances. Each such meeting will follow the regulations at the time of the meeting.

Reappointments and Vacancies

When the term of office of a college board member expires, the appropriate local political subdivision shall either reappoint the member or appoint a new member. If the member whose term of office has expired is eligible for reappointment, that member shall continue in office until reappointed or a successor named. A member who is not eligible for reappointment shall discontinue service on the college board at the expiration of the term. (Section 2A-2.9D-3e)

Whenever a vacancy occurs on the college board, the appropriate political subdivision shall appoint a person to fill the unexpired term of the member creating the vacancy. (Section 2A-2.9D-3e)

Should a member find it impractical, for personal or business reasons, to regularly attend board meetings and is absent for three consecutive meetings or for forty percent or more of the meetings scheduled between July 1 and the next succeeding June 30, he/she shall be notified in writing by the

board chairman that the matter will be presented to the board, in executive session, at the next board meeting.

This notice shall inform the member that he/she may present such justification as he/she may desire or offer to resign.

The community college board will make its determination and, if appropriate, instruct the chairman to notify the jurisdiction concerned of the need for replacement.

Distribution of Representation

The college board membership distribution should be representative of the industries, businesses, and professions which are located in the service area of the college. To ensure an appropriate membership distribution representative of the service area, the State Board established the list of employment categories shown below to assist and guide the College Board Chairman and local government jurisdictions in the selection and appointment process. The President and College Board Chairman should work closely with the local jurisdictions in order to maintain a membership distribution representative of the college service area. (Section 2A-2D-3g)

Conflict of Interest

No member of a local college board shall apply for a full or part-time position in the VCCS while serving as a member of a local college board. Each community college is prohibited from employing for remuneration, in any capacity whatsoever, either on a full-time or part-time basis, a member of the college's board, or the Board member's immediate family. (Section 3.03-3.3.3b2)

In addition, according to the Code of Virginia, members of the College Board are required to file a financial disclosure statement annually by February 1. All filing notices will be sent from the Ethics Council online system and reminder emails from the President's Office. Training is provided to all individuals who are required to file upon request (and at least every two years).

Categories for Community College Board Membership

Agriculture	Law
Air Conditioning & Heating	Law Enforcement
Allied Health	Machinery and Equipment
Aluminum	Meat, Dairy, Poultry and Fish Products
Architect	Medical Equipment and Supplies
Associations–Public Service	Medicine
Associations–Trade	Metal, Mining and Refining
Automobile Industry	Military Personnel
Beverages	Mineral Oil Industry
Broadcasting Service	Musical Instruments and Merchandise
Materials	Office Appliances, Equipment, & Stationery
Business Service	Optical Goods and Services
Chemical Industry	Osteopathy
Clothing Industry	Paints, Oils and Decoration
Coal Industry	Paper Industry
Communication Service	Pharmacy
Construction Service	Photography
Dentistry	Plastics Industry
Dry Goods and General Merchandise	Plumbing
Education	Power Production Equipment and Electrical Supplies
Industry and Electronics	Printing and Publishing
Engineering	Public Relations and Advertising
Entertainment	Public Utilities and/or Service
Exhibitions	Pure Science
Finance	Real Estate
Fire Fighting and Prevention	Recreation
Firearms and Explosives	Refrigeration
Food Industry	Religion
Funeral	Retired
Furniture and Home Furnishings	Rubber Industry
Gas Industry	Ships and Nautical Equipment
Glass Industry	Shoe Industry
Government	Stone Industry
Hardware	Storage
Homemaking	Textile Fibers
Horticulture	Tobacco Industry
Hotels, Resorts, and Restaurants	Transportation
Institutions and Hospitals	Vehicle Industry
Insurance	Veterinary Medicine
Iron & Steel Industry	Wood Industry
Jewelry	
Laundry, Cleaning and Dyeing	

Duties and Responsibilities

A college board shall perform such duties with respect to the operation of a community college as may be delegated to it by the State Board. In general, a college board is responsible for assuring that the community college is responsive to the needs existing within its service region within the statewide policies, procedures, and regulations of the State board. The specific duties of a college board include the following: (Section 2A-2.9D-3h)

- A. The college board shall elect a chairman and other such officers from its membership as it deems necessary and shall adopt such rules and regulations as are considered necessary to conduct its business in an orderly manner.
- B. The college board and the members thereof shall serve as channels of communication between the State Board and the governing bodies of the local political subdivisions.
- C. The college board shall submit its recommendations to the State Board for a name for the community college and each campus of a multi-campus college. In the name of each community college shall be included the phrase "Community College." The college board shall be authorized to provide names for any facilities on the college campus.

Each college shall adopt procedures regarding the naming of major facilities on its campus(es). The procedures may provide for naming on the basis of significant service but should also provide incentives and recognition for private sector giving to support the college. Recognition for private sector giving should typically occur after the gift has been received rather than on a prospective basis.

A current copy of the procedures should be provided to the Office of Facilities Management Services.

Individuals are not eligible for a naming award if they are currently employed at the college or elsewhere within the Virginia Community College System, are serving on the local college board, or serving on the State Board for Community Colleges. In addition, per the Code of Virginia, no college building, park, road, bridge, or other structure shall be named after a sitting member of the General Assembly. A separation from such employment or service of at least one month is a prerequisite for consideration for eligibility of an award.

- D. The college board shall provide recommendations to the State Board on the development of the site plan and on the design, and construction, of facilities for the community college.
- E. The college board shall participate with the Chancellor and the State board in the selection, evaluation, and removal of the president of the community college in accordance with procedures adopted by the State Board.

1) The President shall be evaluated annually. The annual evaluation shall be prepared by the Chancellor based on two independent assessments of the President's accomplishments conducted independently by the College Board and by the Chancellor.

- 2) The Personnel Committee of the NRCC Board, working in conjunction with the President, shall conduct the assessment. An evaluation letter shall be prepared by the Chair of the Personnel Committee (Board Chair) and submitted to the Chancellor no later than May 1 of each year.
 - 3) The Chancellor's assessment will be reviewed with the President no later than June 15 of each year.
 - 4) The Chancellor and the President establish annual goals and objectives for the President's evaluation.
- F. The college board shall participate, with the college president, the Chancellor and the State board, in the development and evaluation of a program of community college education of high quality in accordance with procedures adopted by the State Board. In that context, a college statement of purpose shall be developed by the college community. It shall be approved by the college board and reviewed and approved by the Chancellor on behalf of the State Board. This statement of purpose shall tailor the VCCS Mission Statement to the particular needs and circumstances of the college.
- G. The college board shall be responsible for eliciting community participation in program planning and development, establishing local citizens' advisory committees for specialized programs and curricula, and approving the appointments of all members of these committees.
- H. The college board shall review all new curricular proposals for the community college and shall recommend those proposals that it supports to the State Board. It shall also review proposals for the discontinuation of programs and shall communicate its recommendations on such proposals to the State Board.
- I. The college board shall oversee the development and evaluation of the community service program for the community college and may authorize the president to grant an "award of completion" to a person successfully completing an approved non-credit program.
- J. The college board shall be kept informed of the fiscal status of the college by the college president and shall receive summaries of the biennial financial plan and the annual spending plans.
- K. The college board shall review and approve a detailed local funds budget for the community college as prepared by the college president within State Board guidelines and shall submit this proposed budget to the State Board for review at the time of its submission to the local political subdivisions. In addition, the college board shall submit a financial statement showing detailed expenditures of such local funds to the local political subdivisions and the State Board at the end of the fiscal year.
- L. The college board shall be responsible for reviewing and approving local regulations on student conduct developed by the college president within the guidelines of the State Board.

- M. The college board shall be responsible for the review and approval of a budget prepared by the college president for the expenditure of revenues from vending commissions and auxiliary enterprises, including the student activity fund within the guidelines established by the State Board. The college board shall be responsible for reviewing and approving periodic reports of revenues and expenditures within these funds.
- N. The college board shall be responsible both for reviewing reports of audit and for reviewing the college president's response to those reports of audit.
- O. The college board shall be informed of personnel matters by the college president.

Contact with the State Board

Any college board or its authorized representative may appear before the State Board simply by notifying the Secretary to the State Board of its request no later than fifteen days prior to the next regularly scheduled meeting of the State Board so that this matter may be put on the agenda. (Section 2A-2D-3i)

New River Community College Board

July 1, 2024- June 30, 2025

Names and Home Addresses

Business Addresses

Telephone Numbers

FLOYD COUNTY

Dr. Margaret Dewald-Link
241 Griffith Creek Road
Check, VA 24072

Retired

Home: 540-651-6363
Email: link@swva.net

Mr. Bruce C. (Craig) Chancellor
959 Conner Grove Road SW
Willis, VA 24380

Thomas and Wall
Real Estate
102 N Locust
Floyd, VA 24091

Home: 540-239-5222
Email: trinitycontractorsfsh@gmail.com

GILES COUNTY

Mr. Richard L. Chidester
101 Darden Drive
Pearisburg, VA 24134

County of Giles
County Attorney
315 N. Main Street
Pearisburg, VA 24134
Work: 540-921-2525
Ex1117

Home: 540-921-1262
Email: rchidester@gilescounty.org

Mr. Chris McKlarney
315 N. Main Street
Pembroke, VA 24134

Giles County Administrator
315 N. Main Street
Pearisburg, VA 24134

Work: 540-921-2525
Email:
cmcklarney@gilescounty.org

MONTGOMERY COUNTY

Ms. Jessica Littlejohn
1310 Hillcrest Drive
Blacksburg, VA 24060

Vice President Engineering
Hurt & Proffitt

Home: 540-239-7878
Email: jlittlejohn@handp.com

Mr. Eric K. Johnsen
2045 N. Franklin Street
Christiansburg, VA 24073

State Farm Agency
Owner
2045 N. Franklin St.
Christiansburg, VA 24073

Work: 540-382-5552
Email: eric@ericjohnsen.com

Ms. Bobbie Potter
1320 Flint Drive
Christiansburg, VA 24073

Retired

Home: 540-381-5825
Email: bapotter@vt.edu

PULASKI COUNTY

Mr. William (Bill) K. Cunningham
4756 Lakeland Road
Dublin, VA 24084

Cunningham Real Estate
7464 Lee Highway
Fairlawn, VA 24141

Home: 540-674-0103
Email: kcllc@verizon.net

Mr. Cameron D. Peel
4952 Covey Campground
Dublin, VA 24084

Camrett Logistics
2460 N. 4th Street
Wytheville, VA 24382

Home: 276-724-0663
Email:
Cameron.peel@camrett.com

Mr. Jonathan D. Sweet
6407 Teeth of the Dog Drive
Radford, VA 24141

Pulaski County Administrator
143 Third Street, N.W.
Pulaski, VA 24301

Work: 540-980-7705
Email:
jsweet@pulaskicounty.org

RADFORD CITY

Mr. Christopher Calfee
819 7th St.
Radford, VA. 24141

Summit Community Bank
AVP Commercial Lender

Work: 540-440-0216
Home: 540-440-0216
Email: ccalfee@liberty.edu

Dr. Richard Harshberger
614 Fourth Street
Radford, VA 24141

Retired

Home: 540-239-1978
Email:
dharshberger1@gmail.com

**New River Community College Board
Standing Committees and Officers**

July 1, 2024 - June 30, 2025

Budget and Finance Committee

Ms. Jessica Littlejohn
Mr. Chris McKlarney
Mr. Cameron Peel

Building and Site Committee

Dr. Margaret (Peggy) Dewald-Link
Mr. Eric Johnsen
Mr. Jonathan Sweet

Curriculum and Program Committee

Mr. Craig Chancellor
Dr. Richard Harshberger
Ms. Bobbie Potter

Personnel Committee

Mr. Chris Calfee
Mr. Richard Chidester
Mr. Bill Cunningham

Officers

Mr. Bill Cunningham, Chair
Mr. Christopher Calfee, Vice Chair
Dr. Pat Huber, Secretary

NEW RIVER COMMUNITY COLLEGE BOARD MEMBERS

TERMS OF APPOINTMENT

July 1, 2024 - June 30, 2025

Name	Locality	Length of Initial Term	First Term	Second Term	Third Term
Calfee, Christopher	City of Radford	4	2020-2024	2024-2028	
Chancellor, Craig	Floyd County	4	2020-2024	2024-2028	
Chidester, Richard	Giles County	4	2017-2021	2021-2025	
Cunningham, William	Pulaski County	4	2020-2024	2024-2028	
Dewald-Link, Margaret	Floyd County	15 months	2019-2021	2021-2025*	
Harshberger, Richard	City of Radford	4	2024-2028*		
Johnsen, Eric	Montgomery County	4	2021-2025*		
Littlejohn, Jessica	Montgomery County	4	2018-2022*	2022-2026	
McKlarney, Chris	Giles County	4	2022-2026*		
Peel, Cameron	Pulaski County	4	2020-2024	2024-2028	
Potter, Bobbie	Montgomery County	<1	2019-2020	2020-2024	2024-2028
Sweet, Jonathan	Pulaski County	4	2018-2022	2022-2026	

* Eligible for reappointment at the end of the current term

New River Community College Board

Schedule of Regular Meetings

July 1, 2024 through June 30, 2025

Monday, September 9, 2024

College Board Meeting

Location: NRCC, Christiansburg Site
6:30 p.m. Social; 7:00 p.m. Dinner/Meeting

Monday, December 2, 2024

College Board Meeting

Location: New River Community College
Edwards Hall, room 117
6:30 p.m. Social; 7:00 p.m. Dinner/Meeting

Monday, March 3, 2025

College Board Meeting

Location: NRCC, Dublin Campus
Godbey Hall, room 162b
6:30 p.m. Social; 7:00 p.m. Dinner/Meeting

Wednesday, May 14, 2025

Division of Arts and Sciences Graduation

Location: NRCC, Dublin Campus – E117
4:00 p.m.

Wednesday, May 14, 2025

Division of Business and Technologies

Location: NRCC, Dublin Campus – E117
7:00 p.m.

Thursday, May 15, 2025

Division of Health Professions Graduation

Location: NRCC, Dublin Campus – E117
6:00 p.m.

Monday, June 2, 2025

College Board Meeting

Location: NRCC, Christiansburg Site
6:30 p.m. Social; 7:00 p.m. Dinner/Meeting

Schedule to Review New River Community College’s Mission Statement

NRCC Mission Statement Review Schedule	
Date	Activity
2015	Review Completed
2020	Review by faculty, staff and college constituencies (January) Community input survey (February-March) Review by College Board (June) (Deferred until 2021 due to COVID-19 pandemic)
2025	Review by faculty, staff and college constituencies (January) Review by College Board (March)
2030	Review by faculty, staff and college constituencies (January) Community input survey (February-March) Review by College Board (June)
2035	Review by faculty, staff and college constituencies (January) Review by College Board (March)
As needed	Additional review within 12 months of any revision of the Virginia Community College System mission statement

The Mission Statement will be reviewed by the College Board every five years.

Section IV
Curriculum Development

Curriculum and Instruction Committee

TIMELINE

2024-2025

DATE	MEETING/DEADLINE	ACTION
September 27	Deadline	Faculty submission of new and/or revised programs to the academic deans
October 9	Deadline	Dean submission of new and/or revised programs to Vice President's Office.
October 15	Deadline	Vice President's Staff to review and approve program submissions
October 28	Deadline	Vice President's Office submits curriculum proposals to C & I committee
November 6	Deadline	C & I committee makes recommendations to Vice President on program submissions
December 2	Deadline	Board approval of program submissions for upcoming Catalog
January - August	–	Research and development of new programs

NOTE:

Development of new programs can and should occur throughout the academic year. Programs developed between January and August of each year will be subjected to the same review and approval process as shown on page 8. **However, the deadlines listed above must be met to insure current publication of the programs in the Catalog.**

NRCC Curriculum Review Process

(Deadlines for Catalog Publication)

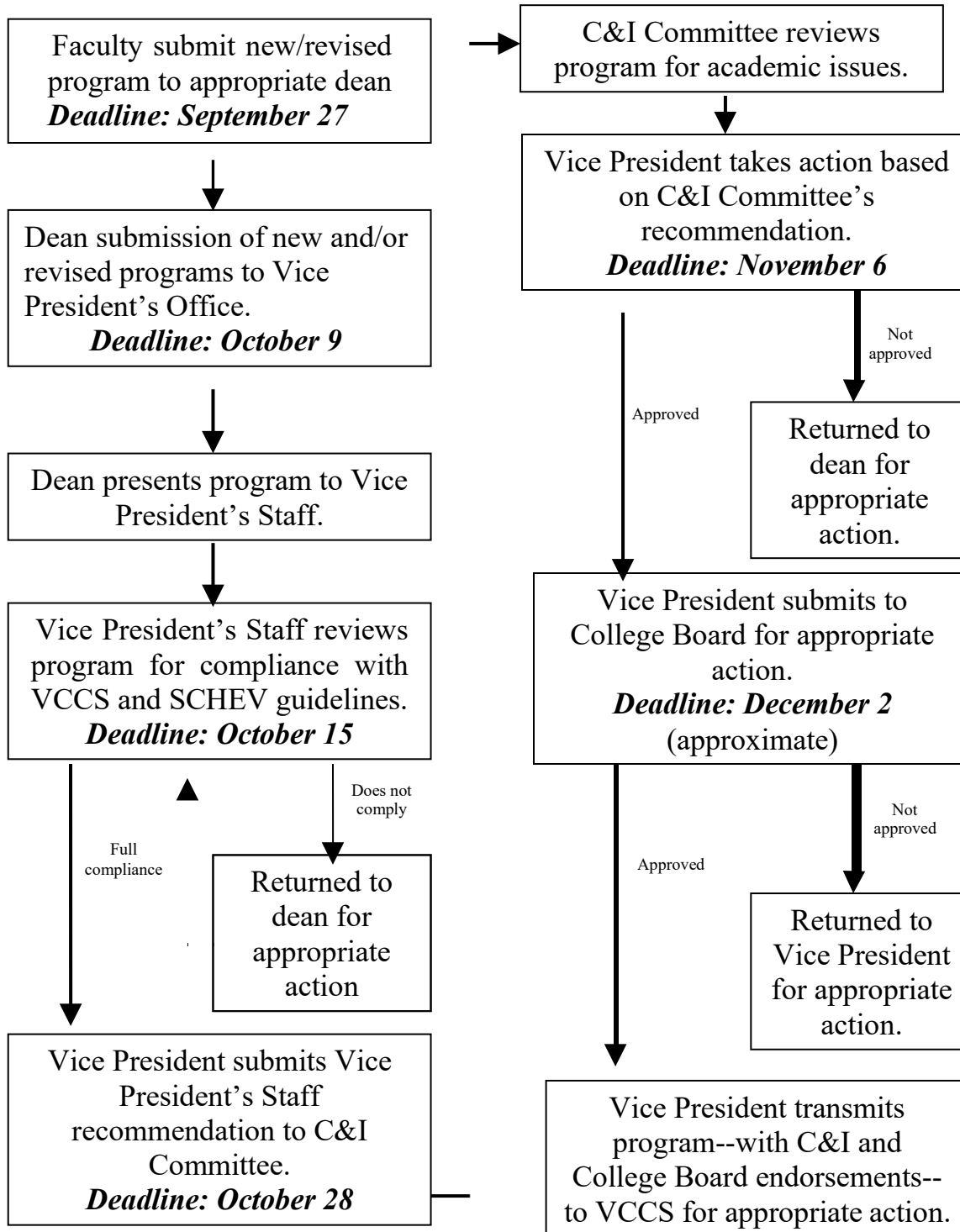

DEFINITIONS

Career Studies Certificate	A program of study in an occupational/technical area not less than 9 nor more than 29 semester credit hours which may include courses numbered 10 – 299. Exempt from SCHEV and VCCS Table 5- 1 requirements.
Catalog	The current New River Community College online catalog (http://catalog.nr.edu).
Vice President’s Staff	Administrative team at NRCC comprised of the Vice President for Instruction and Student Services, the Dean of Arts and Sciences, the Dean of Business and Technologies, the Dean of Student Services, the Dean of Health Professions, the Director of Distance Education, the Director of Library Services, the Financial Aid Manager, and Assessment and Program Review Specialist.
Degree Program	A two-year program of study composed of 100- and 200- level college courses, culminating in a degree. A degree program includes one or more majors, some of which are further divided into appropriate specializations. (See Courses & Programs at http://courses.vccs.edu/).
Major	A program of study consisting of a concentration of courses (30 or more credits) in or closely related to a single discipline and inherently part of an existing degree program. Each major has three instructional cores: general core (25%), specialized and/or degree-related core, and college electives.
Non-Degree Program	A program of study consisting of a concentration of courses in or closely related to a single discipline that culminates in the awarding of a certificate or a diploma. A minimum of 15% of the total credits required to complete the program must be general education courses. Certificate programs (with a minimum of 30 semester credit hours) and diplomas programs are exempt from SCHEV and VCCS Table 5-1 requirements.
Program Proposal	A program proposal consists of all of the elements of documentation required by SCHEV to support the addition of a new <u>degree program</u> . <i>Majors, specializations and non-degree programs do <u>not</u> require preparation of a SCHEV program proposal.</i>
SCHEV	State Council of Higher Education for Virginia (www.schev.edu)
Specialization	A specialized program of study based on a major with 9-15 credits variation from the parent major.
VCCS Courses & Programs	The VCCS online search system classifying curricula with options to search courses, programs and majors or focus on a specific college within the VCCS; also known as the Master Course File . (See Courses & Programs at http://courses.vccs.edu/).

OVERVIEW

According to the VCCS Policy Manual, a new academic program must undergo a certain review process prior to its implementation. Different types of programs require different levels of review depending on the type of program and authority that has been granted by SCHEV. The Policy Manual provides direction for the type and extent of review required for each program, as outlined in Table 5-3 and 5-4 below. See **Section XIII** for an outline of **NRCC Programs** and the classifications.

**Table 5-3
Review & Approval of Transfer Degree Programs and Majors**

Key: R = Review/Recommend A = Approve N = Notification/Reported To	Courses	Career Studies Certificates	Certificates	Diplomas	Degree Programs	Majors	Specializations
Local Level							
Curriculum Advisory Committee	-	R	R	R	R ¹	R ¹	R ¹
College Curriculum Committee	R	R	R	R	R	R	R
College Administration	A	A	A	A	A	A	A
College Board	-	A	A	A	A	A	A
Southern Association of Colleges and Schools	-	N/A ⁴	N/A ⁴	N/A ⁴	N/A ⁴	N/A ⁴	N/A ⁴
State Level							
Deans' Course Review Committee Reporting to ASAC	R	-	-	-	-	-	-
VCCS AS&R Staff	A	N	R	R	R	R	N
Chancellor	-	-	A/N ²	-	-	-	-
Academic Services and Workforce SBCC Committee	-	-	R	R	R	R	-
State Board for Community Colleges	-	-	A/N ²	A	A	A	-
SCHEV	-	-	N	N	A ³	-	-

¹Only for AAA and AAS degree programs

²Original requests must be approved; additional colleges' requests need only be reported

³Must be approved by State Council of Higher Education at least 6 months prior to requested program implementation semester. "Spin-off" degree programs (such as turning a specialization of a current degree program into a stand-alone degree program) require SCHEV staff approval.

⁴SACS must be notified if the new program is related to programs already approved at the college and does not represent a potential substantive change. If the new program does represent a substantive change from approved college programs, SACS approval is required.

Table 5-4

Review and Approval of Career/Technical Programs

Key	Action					
	Degree (AAA, AAs)	Major	Specialization	Diploma	Certificate	Career Studies Certificate
R = Review/Recommend A = Approve N = Notification/Reported To						
Local Level						
Curriculum Advisory Committee	R	R	R	R	R	R
College Curriculum Committee	R	R	R	R	R	R
College Administration	A	A	A	A	A	A
College Board	A	A	A	A	A	A
State Level						
VCCS AWP Staff	R	R	N	R	A	N
Chancellor					A/N ²	
Academic, Workforce Development, and Student Affairs Committee of the State Board	R	R	-	R	R	-
State Board for Community Colleges	A	A	-	A	A/N ²	-
SCHEV Staff	R	-	-	R	R	-
State Council	A	-	-	N	N	-
Regional Accreditation						
SACSCOC	A/N ¹	A/N ¹	A/N ¹	A/N ¹	A/N ¹	A/N ¹
¹ Colleges should adhere to current SACSCOC guidelines for substantive change. ² Original requests must be approved; additional colleges' requests need only be reported.						

VCCS Policy Manual – Section 5

Degree Awarded	NR Programs		Major/Specializations		Certificate/Diplomas		Career Studies Certificates (CSC)*		CIP Code	
	VCCS Code	Degree Title	VCCS Code	Degree Title	VCCS Code	Title	VCCS Code 221-xxx-xx	Title		
Associate of Sciences (AS) Transfer Degrees	213	Business Administration							52.0201 Business Administration and Management, General	
	831	Engineering	831-01	Computer Science					14.0101 Engineering, General	
	880	Science							30.0101 Biological and Physical Sciences	
	246	Computer Science							11.0701 Computer Science	
	625	Education							13.0101 Education, General	
	699	General Studies							24.0102 General Studies	
Associate of Arts (AA) Transfer Degrees	648	Liberal Arts	648-01	Fine Arts					24.0103 Humanities/Humanistic Studies	
			648-02	Visual Communication Design						
					695	Uniform Certificate of General Studies (Cert)			24.0199 Liberal Arts & Sciences, General Studies & Humanities, Other	
Associate of Applied Science (AAs) Career/Technical Education Degrees	203	Accounting					203-01	Accounts Receivable/Payable	52.0399 Accounting & Related Services, Other	
							203-05	Cost Accounting Clerk		
							203-06	Payroll Clerk		
	212	Business Management						212-14	Human Resource Practices	52.0299 Business/ Managerial Operations, Other
								212-04	Management Practices	
	298	Administrative Support Technology	298-02	Medical Administrative Support						52.0499 Business Operations Support & Secretarial Services, Other
			298-03	Paralegal Administrative Support				298-01	Administrative Assistant	
								260-01	Paralegal Assistant	
	729	Engineering Design Technology					729-01	Engineering Design Technology	15.1302 CAD/CADD Drafting and/or Design Technology/ Technician	
	299	Information Technology	299-02	IT Network & Technical Support				299-01	IT-Software Design	11.0101 Computer & Information Sciences, General
			299-12	IT Stack				299-08	IT-Foundations	11.0101 Computer & Information Sciences, General
			299-10	IT Cyber Security						
456	Criminal Justice						400-45	Criminal Justice Foundations I	43.0103 Criminal Justice/ Law Enforcement Administration	
							400-46	Criminal Justice Foundations II		
							400-48	Crime Scene & Criminal Investigation		

Degree Awarded	NR Programs		Specializations		Certificate/Diplomas		Career Studies Certificates (CSC)*		CIP Code			
	VCCS Code	Degree Title	VCCS Code	Degree Title	VCCS Code	Title	VCCS Code 221-XXX-XX	Title				
Associate of Applied Science (AAs) Career/Technical Education Degrees	405	Forensic Science							43.0106 Forensic Science & Technology			
	480	Human Services	480-01	Early Childhood Development					51.1599 Mental & Social Health Services & Allied Professions, Other			
					469	Human Services (Cert)						
							480-31	Recovery Specialist				
							632	Early Child Development (Cert)		19.0709 Child Care Provider/ Assistant		
									636-04		Child Development	
									636-05		Child Development: Infant & Toddler	
	156	Nursing							51.3801 Nursing- Registered Nurse Training (RN, ASN, BSN, MSN)			
						157	Practical Nursing (Cert)	157-04	Nurse Aide	51.3901 Licensed Practical/ Vocational Nurse Training (LPN, LVN, Cert. Dipl., AAS)		
	146							146-01	Emergency Medical Technician	51.0904 Allied Health Diagnostic, Intervention and Treatment Professions		
								190-01	Health Professions Preparations	51.0999 Allied Health Diagnostic, Intervention, and Treatment Professions, Other		
	941	Electrical Engineering Technology						941-01	Electricity	15.0303 Electrical, Electronic & Communications Engineering Technology/ Technician		
								941-05	Electrical-Construction Technology			
								941-06	Practical Electronics Technician-I			
941-07								Practical Electronics Technician-II				
732-00								IT Network				
732-09								Cybersecurity				
732.08								Cybersecurity and Networking Foundations - I				
732-14	Cybersecurity and Networking Foundations - II											
981	Electronics Technology							47.0105 Industrial Electronics Technology/ Technician				
938	Instrumentation & Control Automation Technology						938-02	Computerized Numerical Control	47.0105 Industrial Electronics Technology/ Technician			

Degree Awarded	NR Programs		Specializations		Certificate/Diplomas		Career Studies Certificates (CSC)*		CIP Code
	VCCS Code	Degree Title	VCCS Code	Degree Title	VCCS Code	Title	VCCS Code 221-XXX-XX	Title	
Associate of Applied Science (AAs) Career/Technical Education Degrees	950	Machine Technology					952-03	Basic Machine Tool Operations	48.0599 Precision Metal Working, Other
							952-04	Machine Operations	
							952-05	Machine Technology Fundamentals – I	
							952.06	Machine Technology Fundamentals – II	
							990-00	Industrial Maintenance – I	15.0699 Industrial Production Technologies/ Technicians, Other
							990-01	Industrial Maintenance – II	
					907	Auto Analysis Repair (Dipl)	909-04	Automotive Drivability	47.0604 Automobile/ Automotive Mechanics Technology/Technician
					995	Welding (Cert)	995-00	Fundamentals of Welding	48.0508 Welding Technology/Welder
							995-02	Advanced Welder	
							736-10	Advanced Manufacturing – I	15.0613 Manufacturing Engineering Technology/ Technician
							736-11	Advanced Manufacturing – II	
							736-02	Mechatronics Fundamentals	
							736-03	Applied Mechatronics	
						828-10	Alternative Energy	03.0101 Natural Resources/ Conservation, General	
						903-10	Refrigeration & Air Condition	47.0201 Heating, Air Conditioning, Ventilation & Refrigeration Maintenance Technology/ Technician (HAC, HACR, HVAC, HVACR)	
						917-02	Construction Technology	46.0000 Construction Trades, General	
						285-01	Medical Office Assistant	51.0799 Health & Medical Administrative Services, Other	

Degree Awarded	NR Programs		Specializations		Certificate/Diplomas		Career Studies Certificates (CSC)*		CIP Code
	VCCS Code	Degree Title	VCCS Code	Degree Title	VCCS Code	Title	VCCS Code 221-xxx-xx	Title	
Associate of Applied Science (AAs) Career/Technical Education Degrees							152.00	Medical Coding Foundations – I	51.0707 Health Information/Medical Records Technology/Technician
							152.01	Medical Coding Foundations – II	
							820-04	Practical Electrical Energy Technician – I	15.0599 Environmental Control Technologies/Technicians, Other
							820-05	Practical Electrical Energy Technician – II	
							968-78	Engineering Design Fundamentals – I	15.0000 Engineering Technology, General
							968-79	Engineering Design Fundamentals – II	
							942-01	Practical Electrical Technician – I	46.0302 Electrician
							942-02	Practical Electrical Technician – II	
							810-01	Unmanned Systems	49.0101 Aeronautics/Aviation/Aerospace Science and Technology, General

NOTE: The VCCS code for all Career Studies Certificates (CSC) begins with **221**

PROGRAM TOTALS:

AS Degrees- 6	AAS Degree-13
AS Major/Specializations-1	Diplomas-1
AA Degrees-1	Certificates-5
AA Major/Specializations-2	Career Studies Cert.-54

Curriculum Advisory Committees

Curriculum advisory committees for specialized programs and career/technical curricula are utilized in the establishment and evaluation of such programs. Membership is comprised of local citizens who are recommended by the president to the college board for approval.

Local curriculum advisory committees act in an advisory capacity to the college. Within the area of its educational, career/technical interest and specialty, the committee may:

Help to identify program needs within the college's service regions and the skills and knowledge required of prospective employees;

Advise the college concerning employment practices, specific certification and licensure requirements, job entry educational levels, standards and regulations pertaining to employment and occupational placement of graduates;

Review and submit recommendations regarding program proposals and specialized equipment and facility requirements for new or innovative programs;

Assist with the recruitment of students by publicizing college programs and employment opportunities;

Promote understanding and support of the community college and its programs by maintaining liaison relationships with the community college and regional business, industry, professional, and government organizations and agencies;

Participate in the evaluation of community college programs as they relate to the educational and occupational needs of the region.

Curriculum advisory committees meet as needed and at least once annually.

Section V
NRCC Educational Foundation

NRCC EDUCATIONAL FOUNDATION, INC.

Established in 1980, the NRCC Educational Foundation, Inc., is a non-profit corporation which secures voluntary support and manages, invests, and expends such funds solely for the benefit of New River Community College.

The Foundation Board of Directors, who represents the counties of Floyd, Giles, Montgomery, and Pulaski, and the city of Radford, volunteer their expertise and service on behalf of the college and the community.

The Foundation assists New River Community College in a variety of ways: through the endowment and distribution of scholarship funds, the purchase of equipment and furnishings, and the financial support of academic and community enrichment programs. For more information, call (540) 674-3655.

Endowed Scholarships

Bill and Nancy Aden Scholarship
Mark B. Adkins Memorial Scholarship
AEP Foundation Scholarships – NRV ACCE
Fary Wyrick Anderson Scholarship
William M. Anderson Memorial Scholarship
Bane Atkinson Blacksburg Rotary Scholarship
Bane and Margaret Atkinson Scholarship
Atlanta Union Bank Scholarship
AT&T Scholarship
BB&T Scholarship
O.G. and Ella Bailey Memorial Scholarship
Bank of America Scholarship
Edwin L. Barnes Faculty/Staff Scholarship
Barnes Family Scholarship
Daniel and Joanne Bell Scholarship
Stuart Beville Blacksburg Rotary Vocational
Scholarship
Jo Ann M. Bingham Nursing Scholarship
John C. “J” Bingham Scholarship
Robert L. Blake Scholarship
Jack and Martha Bolt Scholarship
Debra Bond Scholarship
H. T. and Ola Bowling Scholarship
L. Allen and Marilyn Bowman Scholarships
David E. Bradley Scholarship
Joanne E. DeCorse Bradley Scholarship
John and Mary Jean Brown Scholarships
June and Peter Kavolius/Connie and John F. Browne
Scholarship
Lottie Collins Burks Memorial Scholarship
Carilion Nursing Scholarship
Celanese Corporation Scholarship
CELCO Federal Credit Union Scholarship
Chachra Family Scholarship
Ronald Chaffin and Family Scholarship
Warren and Iris Agee Childers Scholarship
William E. “Bill” Christian, Jr., M.D., Nursing
Scholarship
Bill and Linda Cline Scholarship
Fred N. Cole Memorial Scholarships
Danny Cook Scholarship
Lee Cook Scholarship
Corning Incorporated Scholarship
C. Clarke Cunningham, Jr Memorial Scholarship
T. S. and Lillian Dalton Scholarship
James B. Darcy Memorial Scholarship
William C. and Sandra C. Davis Scholarship

Endowed Scholarships (Continued)

Lester L. “Skip” Lamb Nursing Scholarship
Jack and Mary Ann Lewis Scholarships
George and Marjorie Lyle Scholarship
Melvin G. Mabry Scholarship
William B. MacLeod Memorial Scholarship
James G. Manns, Jr., Scholarship
Samuel Adams Martin Memorial Scholarship
Darrel Dennis Martin Memorial Scholarship – Giles
County ACCE
Martin’s Pharmacy Scholarship
Odell and Novella Mayberry Scholarships
Thomas J. and Jane O. McCarthy Memorial
Scholarship
Thomas J. McCarthy, Jr., Scholarship
Robert H. McDaniel Scholarship – Pulaski ACCE
William F. McGuire Scholarship
Mills Family Scholarship
Moog Components Group Scholarship
James and Mary Ellen Moore Scholarships –
Radford City ACCE
Joseph Moore Memorial Scholarship
Moore Family Scholarship
W. E. C. Moore Scholarships
Burke Mottesheard Criminal Justice Scholarship
Kirk Edward Nairn Memorial Scholarship
National Bank Scholarships
New River Valley Charitable Trust Scholarships
New River Valley Emergency Squad Scholarships
New River Valley Health Foundation Scholarships
New River Valley Science Scholarship
New River Valley Shares Scholarship
Hiawatha and Beverly Nicely Scholarships
D. Travis Nichols Memorial Scholarship Osborne-
Kirk Scholarship
Elizabeth “Libby” Vansant Osborne Memorial
Scholarship
Paul L. Phillips Scholarship
Polansky Family Scholarship
Frederic H. and Catherine M. Pollard Scholarship
David C. Poteet Scholarship
Carol C. Powell Scholarship
Les and Joyce Pugh Scholarships
Jim and Janet Rakes Scholarship
Jim and Janet Rakes Scholarship – Montgomery
County ACCE

Brenton Forrest Dean Scholarship
 Deeda Scholarships
 Rita H. Dixon Scholarship
 Bob and Cornelia Dobyngs Scholarships
 Richard Allison & Martha Snow Dobyngs Memorial
 Scholarship
 Kathryn S. Dowling Scholarship
 Dublin High School Alumni Scholarship
 Dublin Lions Club Scholarship
 L. T. Dudley Memorial Scholarship
 Duncan-Thomas Family Scholarship
 Dennis and Susan Duncan – Giles ACCE Scholarship
 Gary and Rhonda Duncan Scholarship
 Paul and Elfreeda Duncan Scholarships
 Randall and Anna Edwards Scholarship
 Betty and Bill Elmore Scholarship
 William Howell Elmore Memorial Scholarship
 L. Brinkley Eure Memorial Scholarship
 Nancy R. B. Evans Scholarship
 Billie Farmer Memorial Scholarship
 Tina O’Dell Fitzpatrick Memorial Nursing Scholarship
 Joan Flattery, RN Scholarship
 Billy Friend Scholarship
 Michael D. Gallaher Scholarship
 Beth Garter Scholarship
 Ernie Garter Scholarship
 Thomas Jefferson Gates Memorial Scholarship
 Giles High School Class of 1971 Scholarship
 Howard and Mary B. Gilmer Scholarship
 Andrew L and Elrica S Graham Patriotic Memorial
 Scholarship
 Flo and Bob Graham – Radford City ACCE Scholarship
 Hagan Family Scholarship in Memory of Kyle Lee
 Hagan
 John T. and Nannie B. Hairston Scholarships
 Bill Hale Memorial Scholarship
 Eddie and Kathy Hale Scholarship
 Carol Thomas Hancock Scholarship
 Alex M. Harman, Jr., Scholarships
 Albertis Harrison, Jr., Memorial Scholarship
 Rachel Mable Hendricks Memorial Scholarship
 Lewis “Louie” J. Heslip Memorial Scholarship
 Joseph Caudle Hillman Memorial Scholarship
 Ed & Pierrette Huber Scholarship
 Elizabeth Huber Memorial Scholarship
 John H. Huber Memorial Scholarships
 Pete Huber’s Heroes Scholarship
 Ann and H. W. Huff, Jr., Scholarships
 Huff Petroleum Co., Inc. Scholarship

James W. Robertson Memorial Scholarships
 Bethany Lorraine Richter Rooker Scholarship
 Daniel J. Rooker Memorial Scholarship
 Jason Rooker Memorial Scholarship
 Lulu Eliza Rooker Memorial Scholarship
 Marion W. Rose Memorial Scholarship
 Rock and Patty Roszak Scholarship
 Philip Sadler Memorial Scholarship
 Patricia J. Sanders Memorial Scholarship
 William B. Sanders Memorial Scholarship
 Shelor Toyota Scholarship
 Paul C. Shelor Scholarship
 William Raper and Frances H. Shelton and
 Giovanna S. Roop Scholarship
 Jim and Margaret Shuler Scholarship
 Simmerman Family Scholarship
 Cheryl P. Simmons Memorial Scholarship
 Simmons Family Scholarship
 Bobby C. Smith Scholarship
 Catherine Harman Smith Memorial Scholarship
 Helen Gregory Smith Scholarship
 Lee and Judy Smith Scholarship
 Stateson Homes Scholarship
 Paul and Roberta Steele Scholarship
 Deena and Don Stowers Scholarship
 W. Robert Sullins Scholarship
 Grace Eva Mabry Tawes Scholarship
 Peggy Taylor Scholarship
 Tsokahovi Tewanima Scholarship
 Timberlake-Wheeler Scholarship-Gile County
 ACCE
 United Auto Workers Local 2069
 Archa and Marjorie H. Vaughan Scholarship
 Marjorie Hope Harman Vaughan Memorial
 Scholarship
 V. E. (Jack) Vaughn Memorial Scholarship
 Volvo Trucks North America, Inc. Scholarship
 Howard Johnson “Jack” Wade, Jr. Memorial
 Scholarship
 Douglas D. Warren Scholarship
 J. Lewis & Catherine S. Webb Scholarship – Giles
 County ACCE
 Wells Fargo Bank Scholarship
 Anna S. Wentworth Art and Communications
 Scholarship
 Lee and Anne Wheeler Scholarship
 Charlie White Scholarship
 E. Pierce Whitman Memorial Scholarship
 Ellen R. Whitman Memorial Scholarship

William and Sallie Ingles Memorial Scholarship
Robert J. Ingram Scholarship
Bobby and Martha Jackson Scholarship
Alice Webb Johnson Scholarship
Ben and Edwina Karlin Memorial Scholarship
Katz Family Scholarship
David A. Keitz Engineering Scholarship
Michael D. Keitz Engineering Scholarship
Charlene Doby Kilgore Memorial Scholarship
Kilgore Family Scholarship
Wilson, Lura & Jerry Kilgore Memorial Scholarship
Chelsea King Memorial Nursing Scholarship
Gordon and Barbara King Scholarship
Claud K. and Virginia R. Kirkland Scholarship

Jeanne B. Whitman Scholarship
Archie and Geneva Whitt Memorial Scholarship
Mark F. and Lucy B. Williams Scholarship
Wolverine Advanced Materials Scholarship
Thomas E. Worrell, Jr., Scholarship
Jon and Mary Wyatt Scholarship
Everett Lee Yearout, Jr., Scholarship
Eddie Yeatts Scholarship
Eddie Yeatts Endowed Scholarship – Montgomery
County ACCE
Robert Young Scholarship

NRCC EDUCATIONAL FOUNDATION, INC.
2024-2025

Board of Directors



Mr. Bill Aden
Ms. Diane Akers
Mr. John Brown
Mr. Kevin Browne
Mr. Angela E. Covey
Ms. Sandra C. Davis
Dr. Randall Edwards*
Mr. Bill Flattery
Dr. Florine Graham*
Mr. Eddie Hale*
Mr. Gary Hancock
Mr. Vince Hatcher
Dr. Patricia B. Huber
Mr. Edward Lawhorn*
Mr. Jim McAlister

Mr. Craig Meadows
Mr. Hiawatha Nicely*
Dr. Karanita Ojomo
Mr. Wayland “Street” Overstreet*
Mr. Andrew D. Owens*
Mr. James Rakes
Mr. David Ridpath
Mr. Todd Robertson
Mr. Larry Shelor
Mr. L.T. Simmons*
Dr. Martha Ann Stallings
The Honorable Michael B. Watson*
Dr. J. Lewis Webb*
Mrs. Anne Wheeler*
Mr. Keith Weltens

**Emeritus Directors*

Section VI
Minutes

Section VII

Maps

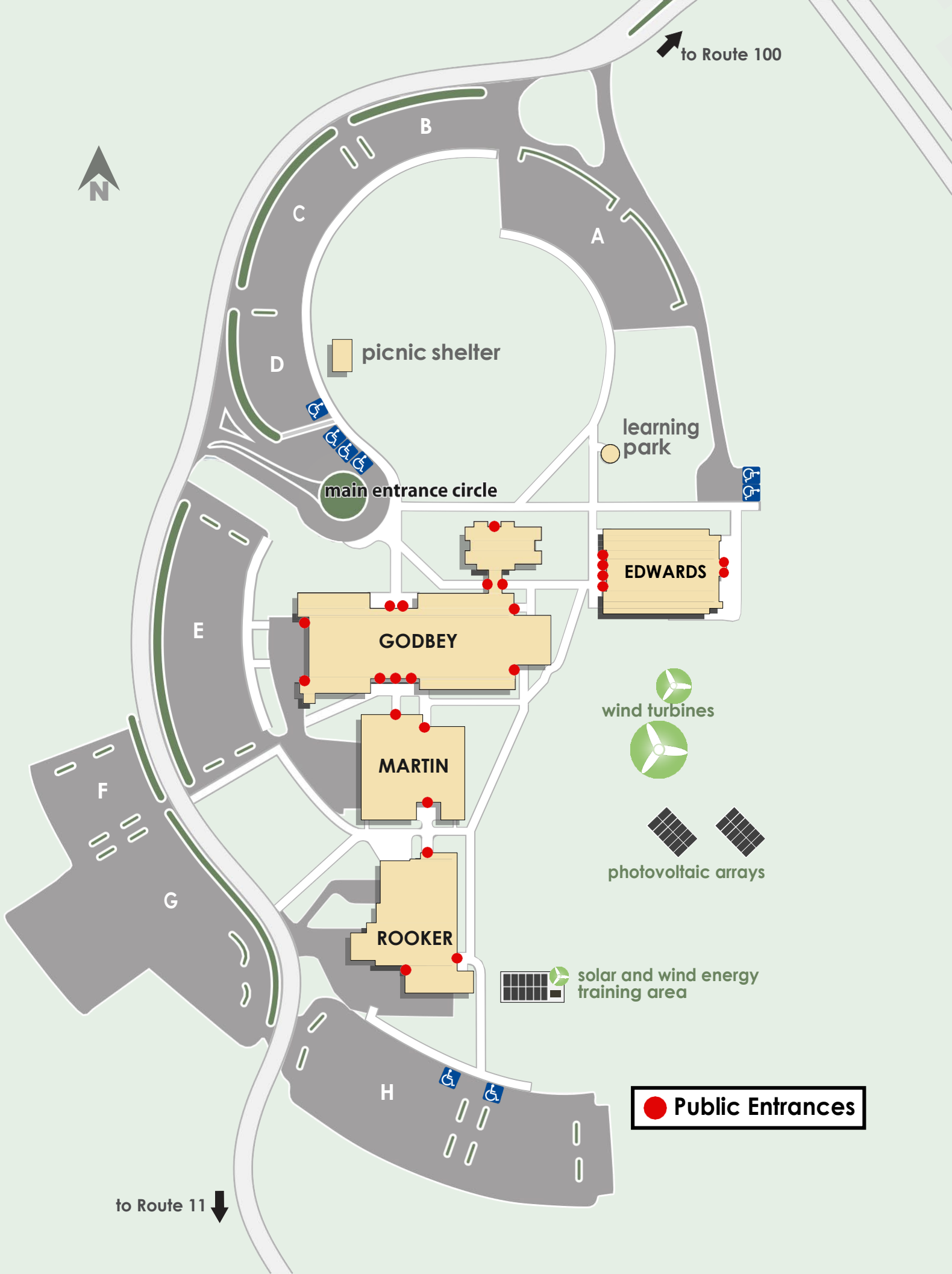

to Route 100



picnic shelter

learning park

main entrance circle

EDWARDS

GODBEY

wind turbines

MARTIN

photovoltaic arrays

F

G

ROOKER

solar and wind energy training area

H

Public Entrances

to Route 11



to Edwards Hall

to Parking Lots B, C & D

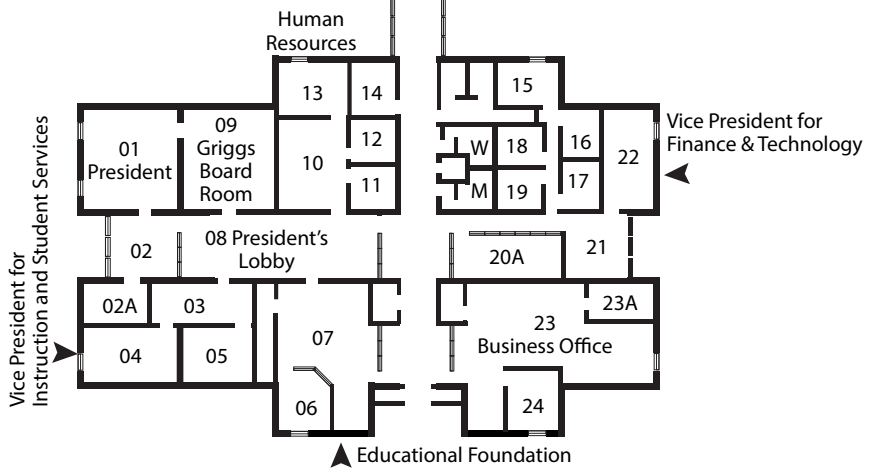

GODBEY HALL

STORM SHELTER

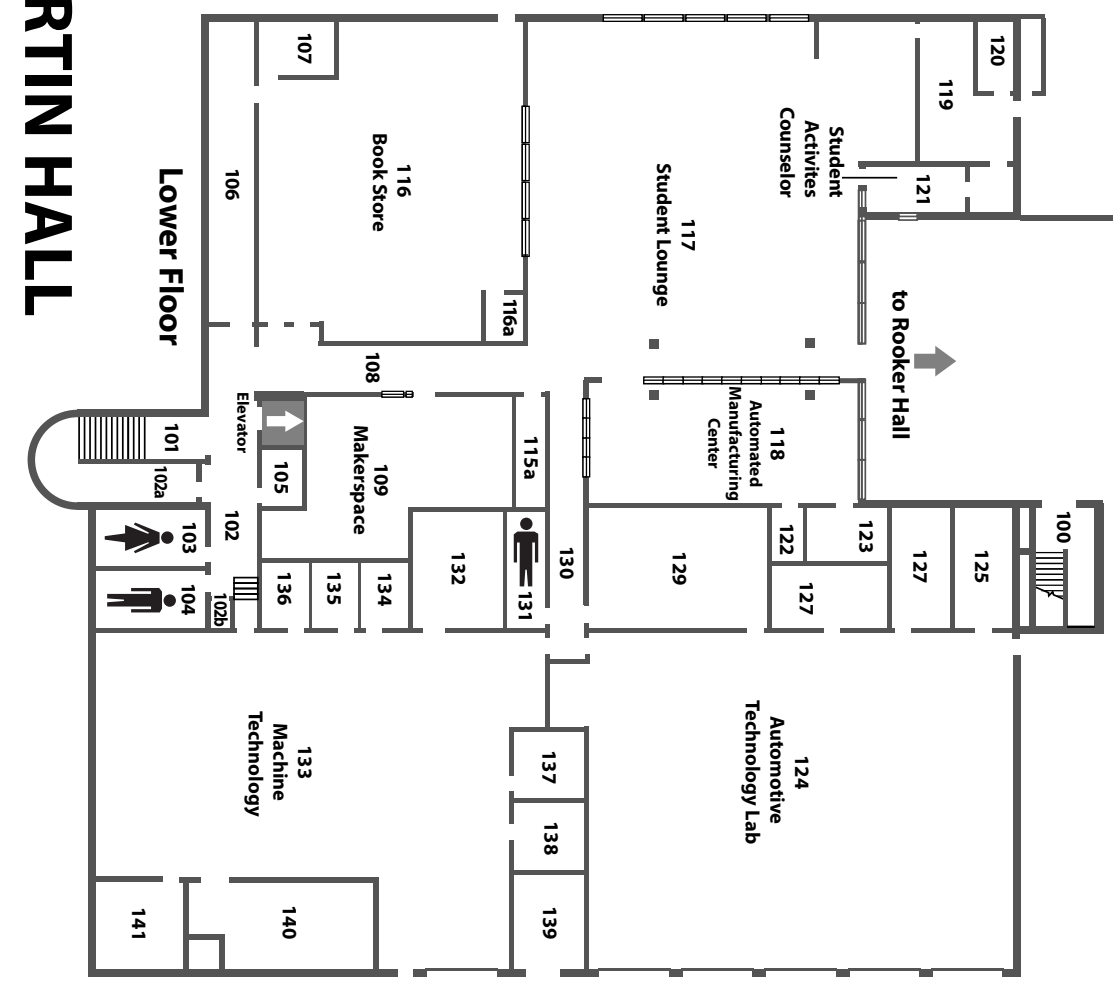
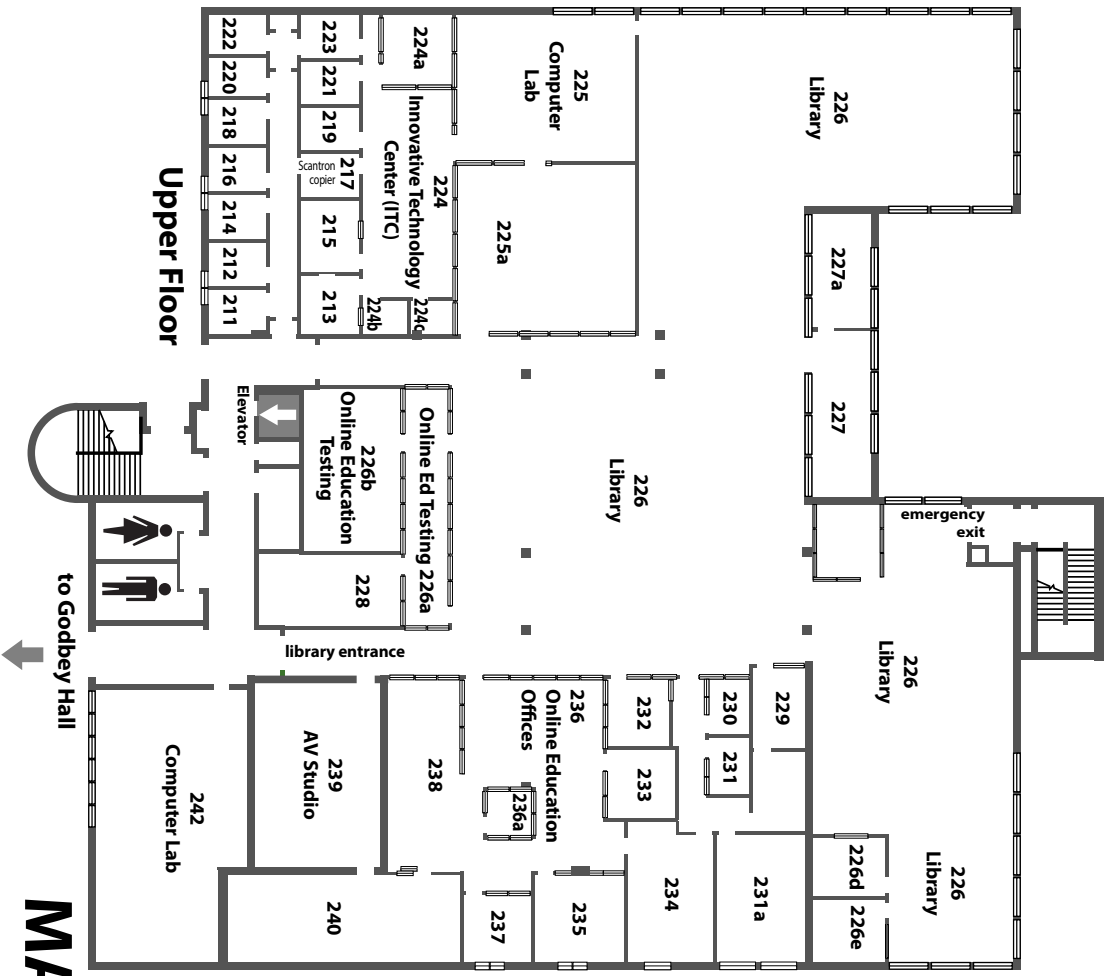

MARTIN HALL

Information Technology

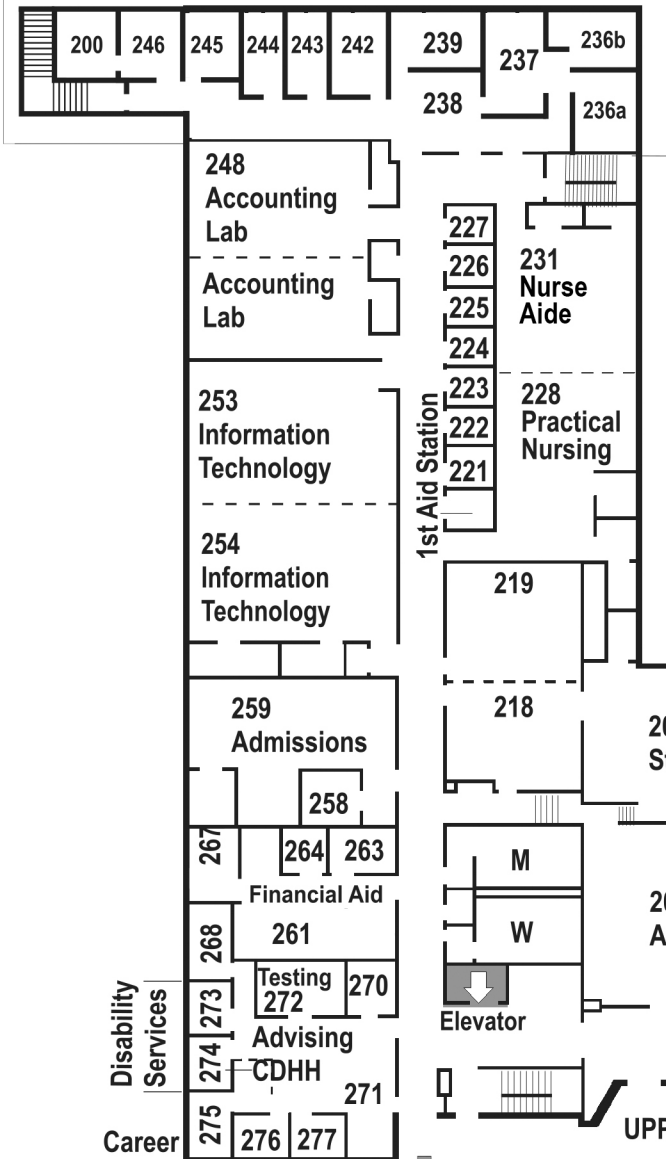

TO MARTIN HALL

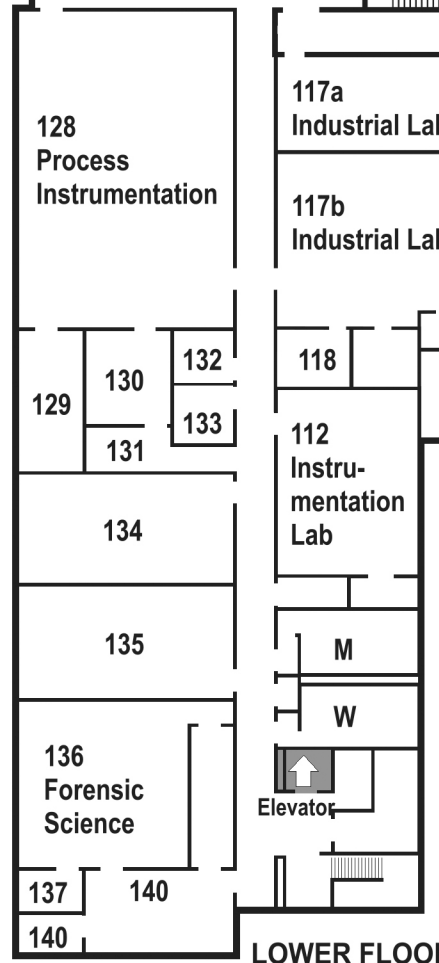
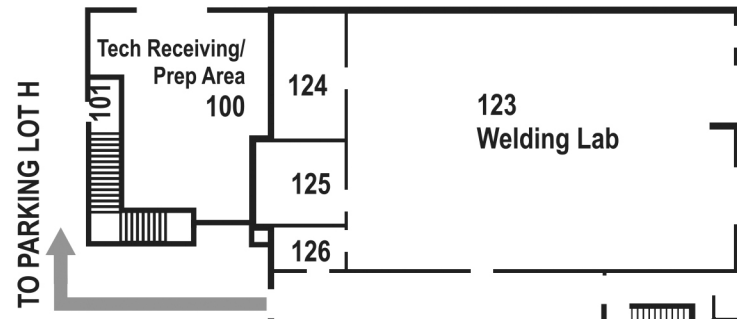

ROOKER HALL

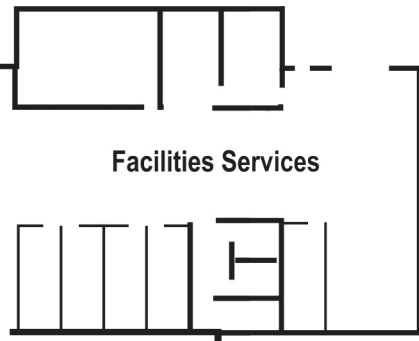

TO PARKING LOTS G & H

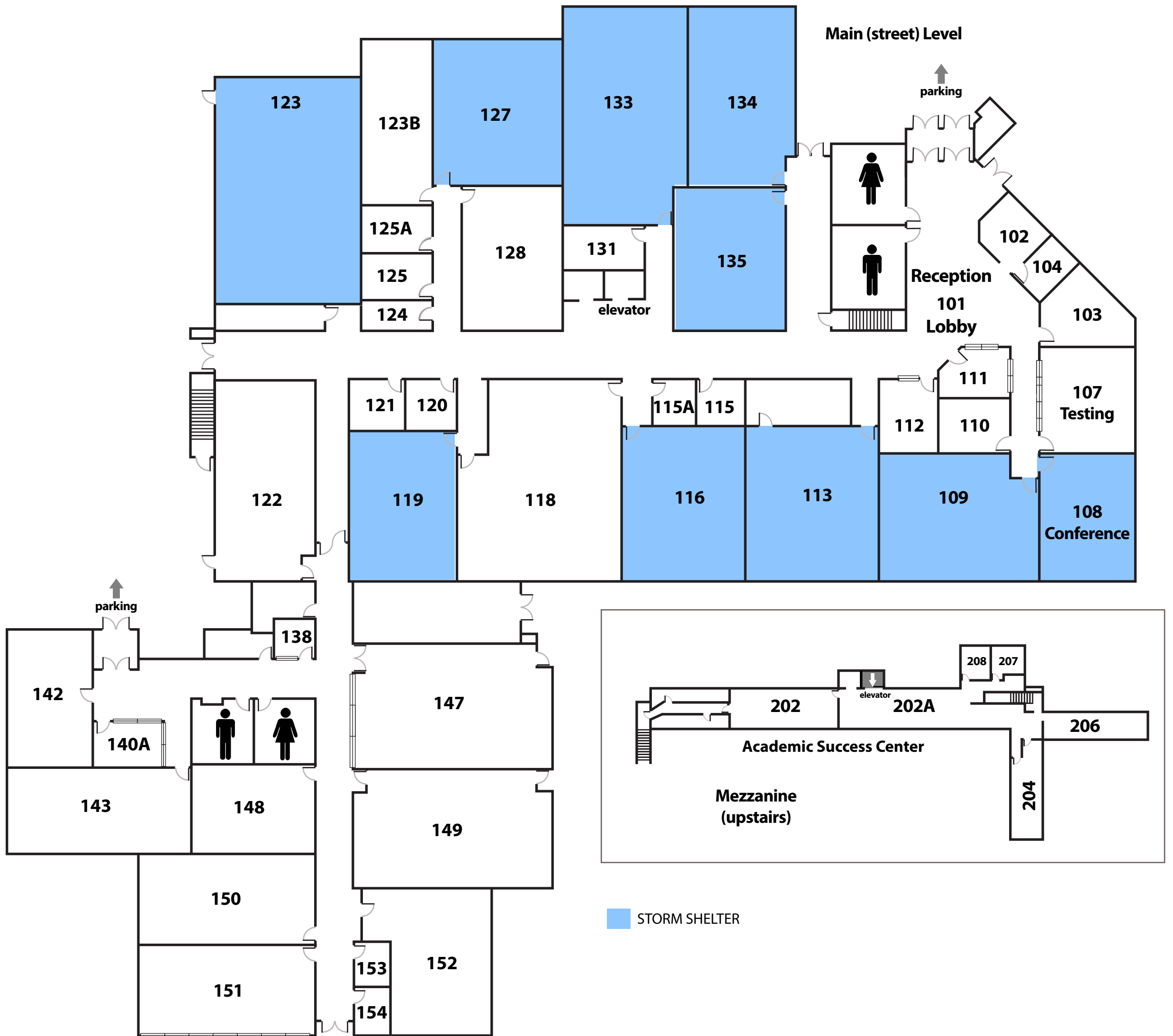

Christiansburg Site